

Description

GPJ09-5817 FOSC (Fiber Optic Splice Closure) series offer a unique solution for big capacity solution for deployment of fiber to the home. 5817 FOSC series of dome closure is a family product line, available in three sizes : the 5817-A, 5817-B and 5817-C. All sizes are designed for use with comment cable construction (loose buffer tube, loose fiber), in any environmental (aerial, pedestal, buried, handhole, manhole). The GPJ09-5817-B closure is the middle in the 5817 FOSC series which provide max capacity up to 360f.

Feature

- Made of modified engineering plastic with high strength, anti impact and anti corrosion.
- Cable diameter: 1 uncut port meet $\phi 10 \sim 25\text{mm}$ cable; 4 branch ports meet $\phi 14 \sim 22\text{mm}$ cable;12 branch ports meet $\phi 8 \sim 16\text{mm}$ cable
- Product capacity: Single fiber max capacity is up to 360f, each tray support 12f or 6f
- Installation method: Suitable for direct buried, aerial, pole,pipeline,manhole, etc.
- Sealing mode: heat shrink seal is adopted for cable ports, with protection grade of IP68.
- 3 types of splice trays are available for selection, including 12f tray, 6f tray and splitter tray

Specification

Model No.	GPJ09-5817-B		
Style	Dome		
Dimensions(mm)	500 × Φ 270		
Weight (kg)	7.5 - 8.0		
Material	PP+GF		
Sealing Type	Heat shrink Seal		
Protection Grade	IP68		
Cable ports	Oval port	1	$\Phi 10 - \Phi 25$ mm
	Branch port	4	$\Phi 14 - \Phi 22$ mm
		12	$\Phi 8 - \Phi 16$ mm
Closure Max Capacity	Single fiber splicing		360f
Splice Tray Capacity	Single fiber splicing per tray		12f/6f
Max No. tray installed	30pcs/60pcs		
Splitter	2pc 1:4 or 1pc 1:8		
Installation	Aerial, wall, pole, underground, pipeline etc.		

Product appearance



Structure Drawing

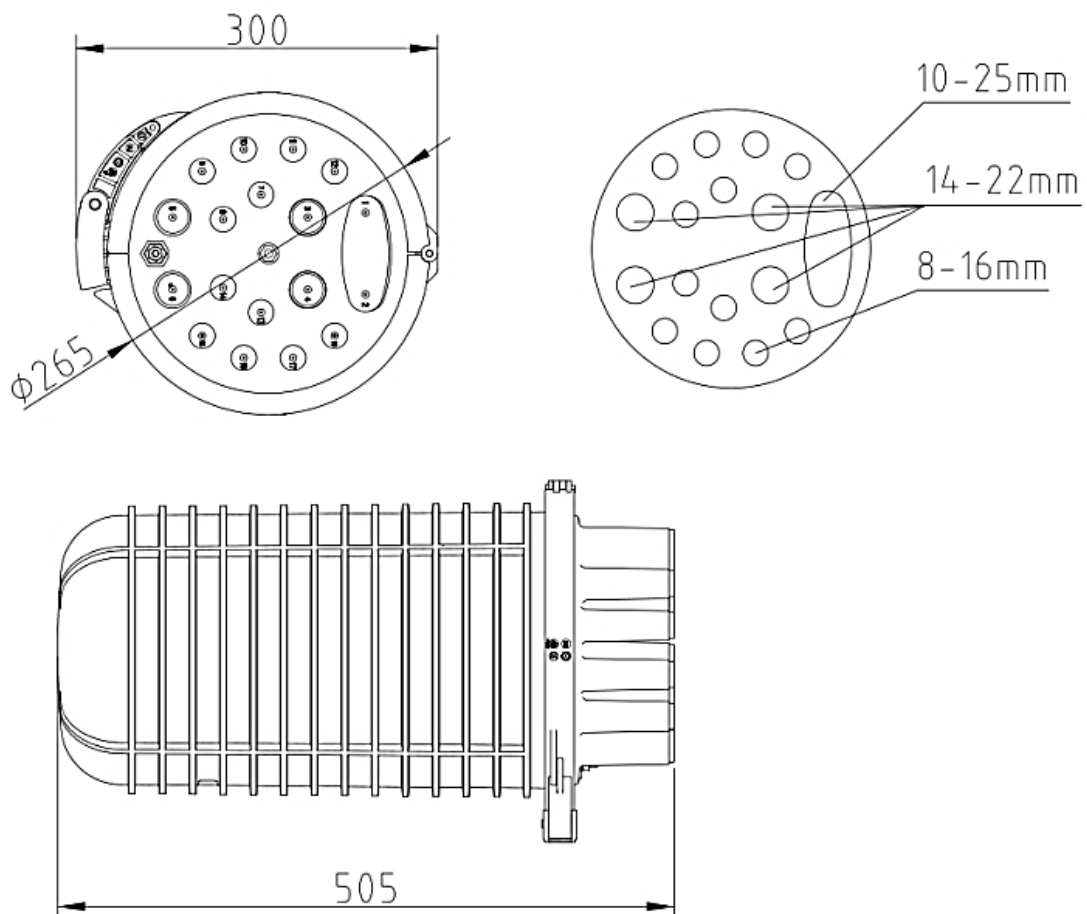







Accessory

- Standard accessories (Picture only for refer)

Item	Description	Qty	Picture
1	Heat shrink tube for uncut port	1 pc	
2	Heat shrink tube for branch port	1 pc	
3	Branch clip	1 pc	
4	Aluminum paper	7 pcs	
5	Insulation tap	1 roll	
6	Splicing protective tube	1 bag	
7	Nylon cable tie	1 bag	
8	Sand paper	1 pc	
9	Installation manual	1 set	
10	EVA tube	1 roll	
11	Clean paper	1 pc	
12	Silicon oil	1 pc	

- Optional accessory (Picture only for refer)

Item	Description	Qty	Picture
1	Air Valve	1set	
2	Ground lead	1 set	
3	Sealing kits	As require	
4	Aerial mounting fittings	1 set	
5	Pole mounting fittings	1 set	
6	Wall mounting fittings	1set	

Ordering information

Type	size	Inner Carton size	Outer carton size
GPJ09-5817-B	Φ500 × Φ270	650×315×285 mm (1 PCS)	None